

**NTN**®

**Large Size Tapered Roller Bearings**  
**ULTAGE Metric Series**



**ULTAGE**®

CAT. No. 3035/E

# ULTAGE®

## Large Size Tapered Roller Bearings ULTAGE Metric Series

Large size tapered roller bearings (ULTAGE metric series,  $OD \geq \phi 270\text{mm}$ ) deliver longer life, higher load ratings, and higher speed capabilities. Developed as the new standard of NTN bearings, the ULTAGE series will contribute to improvements in industrial machinery today and into the future.



### Higher Reliability

- Greater high load capacity by optimizing internal design
- Longer maintenance intervals

### Higher Load Capability

- Allowable misalignment 0.0017 (6°)
- ※Under conditions of  $F_r \leq 0.35C_r$

### Higher Limiting Speed

- Up to 10% increase of allowable speed by optimizing the inner ring, large-end rib, and the roller end

"ULTAGE®" (a name created from the combination of "Ultimate," signifying refinement, and "Stage," signifying NTN's intention that this series of products be employed in diverse applications) is the general name for NTN's new generation of bearings that are noted for their industry-leading performance.

Life  
**x3**

Basic dynamic load rating  
**+30%**

Up to  
**+10%**  
higher allowable speed

Dimensional change  
**1/10**

**Cage**  
• Roller guided type

**Outer ring**  
• Through hardened steel applied  
• Lower dimensional change over time

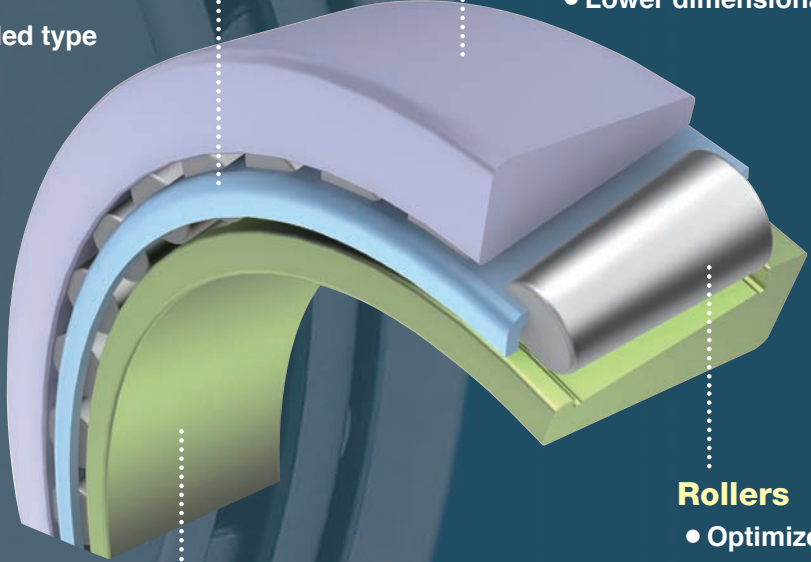

**Inner ring**  
• Through hardened steel applied  
• Lower dimensional change over time  
• Optimized rib design

**Rollers**  
• Optimized crowning

INDEX

<b>1. Features</b> .....	3
1.1 The highest level of reliability	
1.2 Allowable misalignment	
1.3 Allowable speed	
1.4 Improved dimensional stability over time	
1.5 Easily adaptable	
<b>2. Bearing Number</b> .....	4
<b>3. Dimension Table</b> .....	5
3.1 Single row tapered roller bearings .....	5
3.2 Double row tapered roller bearings (Outside direction) .....	7
3.3 Double row tapered roller bearings (Inside direction) .....	10

# 1. Features

## 1.1 The highest level of reliability

The optimized roller crowning delivers a dramatically increased load rating by better distributing load across the roller length, greatly reducing edge stress concentrations as shown in Fig.1.

- ① **Tested life:**  
3.0 times larger than conventional bearings
- ② **Basic dynamic load rating:**  
30% larger than conventional bearings

## 1.2 Allowable misalignment

Misalignment : 0.0017rad (6')

- Optimizations made to the crowning shape allow combinations of 0.35  $C_r$  and misalignment up to 0.0017rad (6') to be used.
- Minimum required load : 0.04 $C_{0r}$

Fig.1 shows the stress distribution when the radial load is below 0.35  $C_r$ . Edge stress is significantly decreased and contact stresses are better distributed along the length of the roller, as compared the stresses resulting from a conventional design.

**[Studied conditions]**

**Bearing size :** 30316U ( $\phi 80 \times \phi 170 \times 42.5$ )

**Load :** 102kN

**Misalignment :** 0.0017rad.

※Since allowable misalignment varies depend on combination of load and misalignment, please consult NTN engineering.

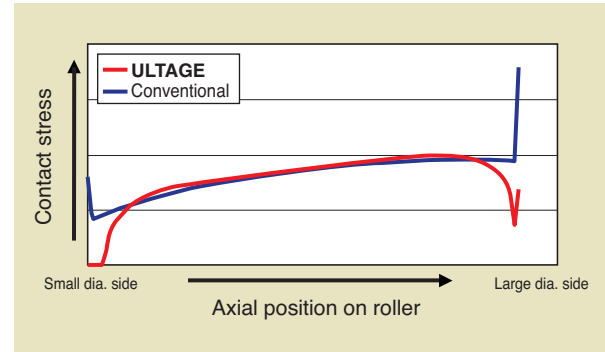

Fig. 1 Stress distribution on roller

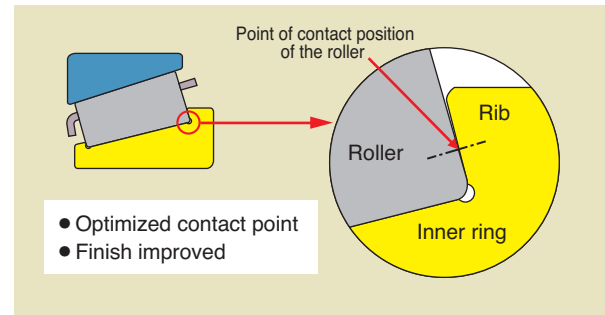

Fig. 2 Optimized design between a roller and an inner ring rib

## 1.3 Allowable speed

The optimized design between the roller and inner ring rib end makes it possible to minimize rotational torque and temperature rise, allowing for up to 10% higher allowable speed when compared to a conventional design as shown in Fig. 2, 3 and 4.

## 1.4 Improved dimensional stability over time

The special heat treatment to the bearing steel allows for better dimensional stability over time, and reduces dimensional change during operation.

- **Less dimensional change**
  - 1/10 compared with through hardened steel
  - 1/4 compared with carburized steel

## 1.5 Easily adaptable

Boundary dimensions and tolerance of bearings comply with ISO 355 (JIS B 1512), ISO 492 (JIS B 1514).

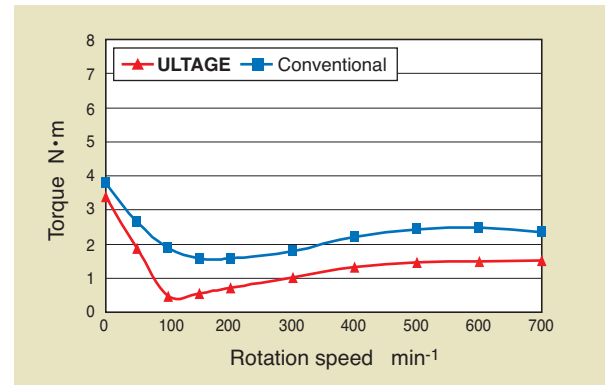

Fig. 3 Torque comparison

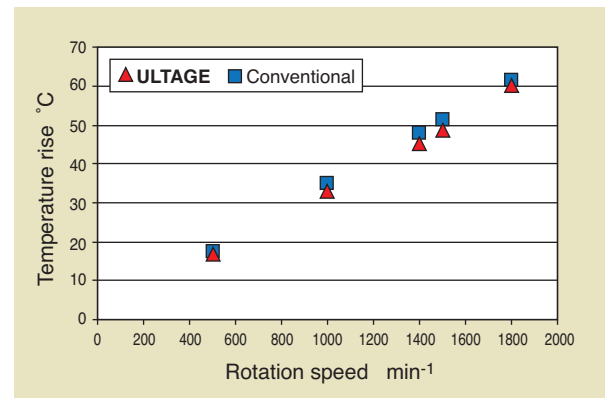
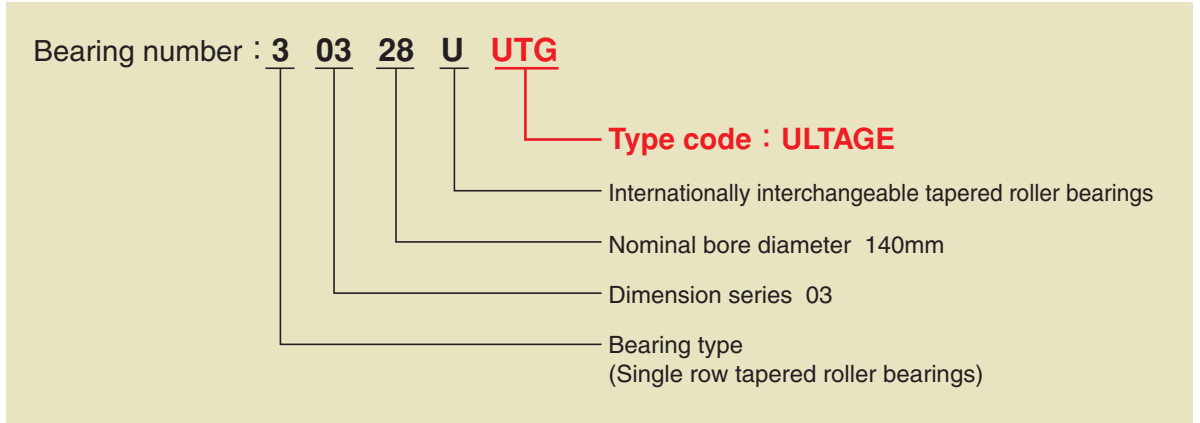

Fig. 4 Temperature rise test

## 2. Bearing Number

### 2.1 Single row tapered roller bearings



### 2.2 Double row tapered roller bearings (Outside direction)

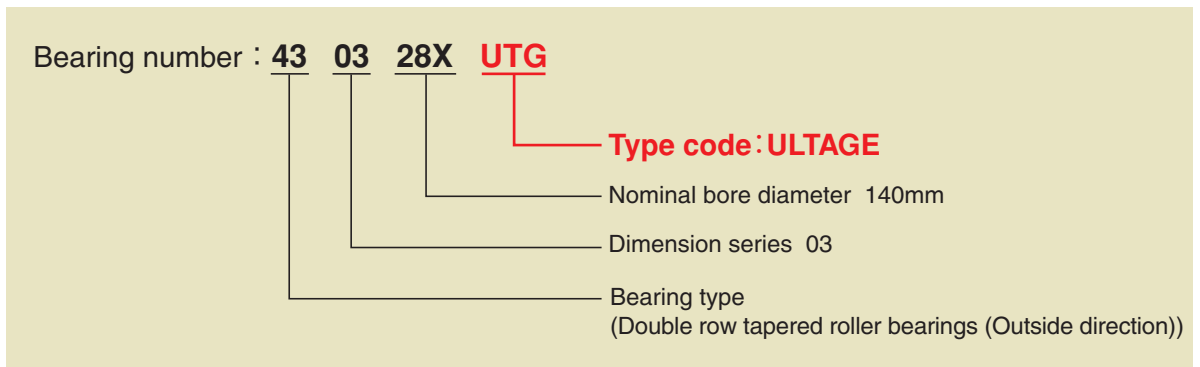

### 2.3 Double row tapered roller bearings (Inside direction)

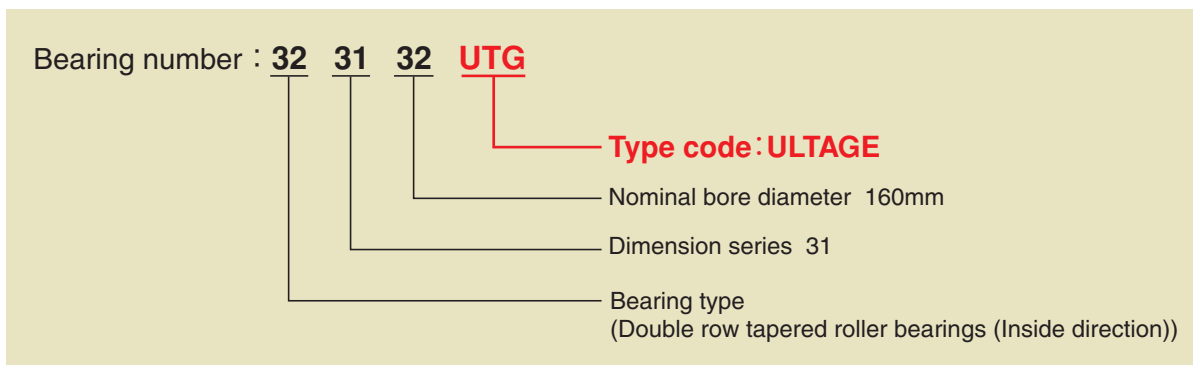

### 3. Dimension Table

#### 3.1 Single row tapered roller bearings

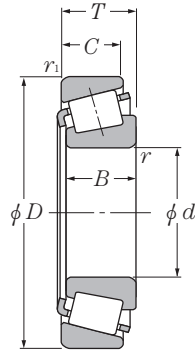

**Equivalent radial load**  
**dynamic**

$$P_r = XF_r + YF_a$$

$\frac{F_a}{F_r} \leq e$		$\frac{F_a}{F_r} > e$	
X	Y	X	Y
1	0	0.4	$Y_2$

**static**

$$P_{or} = 0.5F_r + Y_o F_a$$

When  $P_{or} < F_r$  use  $P_{or} = F_r$

For values of  $e$ ,  $Y_2$ , and  $Y_o$  refer to that of conventional bearings.

d 130~220mm

d	Boundary dimensions mm						Bearing numbers	Basic load ratings			
	D	T	B	C	$r_s$ min <sup>1)</sup>	$r_{1s}$ min <sup>1)</sup>		dynamic kN $C_r$	static $C_{0r}$	dynamic kgf $C_r$	static $C_{0r}$
130	280	63.75	58	49	5	4	30326UUTG	830	830	84 500	84 500
	280	98.75	93	78	4	4	32326UTG	1 140	1 240	117 000	126 000
140	300	67.75	62	53	5	4	30328UUTG	945	950	96 000	97 000
	300	107.75	102	85	4	4	32328UTG	1 260	1 370	129 000	140 000
150	320	72	65	55	5	4	30330UUTG	1 060	1 070	108 000	109 000
	320	114	108	90	4	4	32330UTG	1 490	1 750	152 000	179 000
160	290	52	48	40	4	3	30232UUTG	670	720	68 500	73 500
	290	84	80	67	4	3	32232UUTG	1 140	1 420	116 000	145 000
	340	75	68	58	5	4	30332UUTG	1 170	1 200	119 000	122 000
	340	121	114	95	4	4	32332UTG	1 580	1 840	161 000	188 000
170	310	57	52	43	5	4	30234UUTG	780	845	79 500	86 500
	310	91	86	71	5	4	32234UUTG	1 280	1 600	130 000	163 000
	360	80	72	62	5	4	30334UUTG	1 290	1 320	131 000	135 000
	360	127	120	100	4	4	32334UTG	1 680	1 940	171 000	198 000
180	280	64	64	48	3	2.5	32036XUUTG	825	1 170	84 500	119 000
	320	57	52	43	5	4	30236UUTG	805	890	82 000	91 000
	320	91	86	71	5	4	32236UUTG	1 320	1 690	134 000	172 000
	380	83	75	64	4	4	30336UUTG	1 170	1 190	119 000	121 000
	380	134	126	106	4	4	32336UTG	1 850	2 150	188 000	219 000
190	290	64	64	48	3	2.5	32038XUUTG	840	1 210	85 500	124 000
	340	60	55	46	5	4	30238UUTG	915	1 000	93 500	102 000
	340	97	92	75	5	4	32238UUTG	1 470	1 850	150 000	189 000
	400	86	78	65	5	5	30338UTG	1 190	1 200	122 000	123 000
	400	140	132	109	5	5	32338UTG	2 040	2 390	208 000	244 000
200	280	51	51	39	3	2.5	32940XUUTG	620	895	63 000	91 000
	310	70	70	53	3	2.5	32040XUUTG	1 020	1 470	104 000	149 000
	360	64	58	48	5	4	30240UUTG	1 010	1 110	103 000	113 000
	360	104	98	82	5	4	32240UUTG	1 690	2 130	172 000	217 000
	420	89	80	67	5	5	30340UTG	1 340	1 370	136 000	140 000
	420	146	138	115	5	5	32340UTG	2 230	2 650	228 000	270 000
220	300	51	51	39	3	2.5	32944XUUTG	610	950	62 500	97 000
	340	76	76	57	4	3	32044XUUTG	1 180	1 690	120 000	173 000
	400	72	65	54	4	4	30244UTG	1 040	1 220	107 000	124 000
	400	114	108	90	4	4	32244UTG	1 780	2 410	181 000	246 000
	460	97	88	73	5	5	30344UTG	1 620	1 690	165 000	172 000
	460	154	145	122	5	5	32344UTG	2 580	3 050	263 000	315 000

1) Minimal allowable dimension for chamfer dimension  $r$  or  $r_1$ .

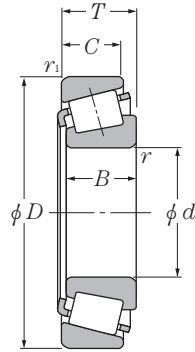

**Equivalent radial load**  
**dynamic**

$$P_r = X F_r + Y F_a$$

$\frac{F_a}{F_r} \leq e$		$\frac{F_a}{F_r} > e$	
X	Y	X	Y
1	0	0.4	Y <sub>2</sub>

**static**

$$P_{or} = 0.5 F_r + Y_0 F_a$$

When  $P_{or} < F_r$ , use  $P_{or} = F_r$

For values of  $e$ ,  $Y_2$ , and  $Y_0$  refer to that of conventional bearings.

**d** 240~440mm

d	Boundary dimensions mm						Bearing numbers	Basic load ratings			
	D	T	B	C	r <sub>s</sub> min <sup>1)</sup>	r <sub>1s</sub> min <sup>1)</sup>		dynamic C <sub>r</sub>	static C <sub>0r</sub>	dynamic C <sub>r</sub>	static C <sub>0r</sub>
240	320	51	51	39	3	2.5	32948XUUTG	625	1 000	64 000	102 000
	360	76	76	57	4	3	32048XUUTG	1 190	1 760	122 000	179 000
	440	79	72	60	4	4	30248UTG	1 250	1 480	128 000	151 000
	440	127	120	100	4	4	32248UTG	2 180	2 750	222 000	280 000
	500	105	95	80	5	5	30348UTG	1 900	2 000	194 000	204 000
	500	165	155	132	5	5	32348UTG	2 990	3 600	305 000	365 000
260	360	63.5	63.5	48	3	2.5	32952XUUTG	905	1 430	92 500	146 000
	400	87	87	65	5	4	32052XUUTG	1 540	2 270	157 000	231 000
	480	89	80	67	5	5	30252UTG	1 500	1 810	153 000	185 000
	480	137	130	106	5	5	32252UTG	2 410	3 350	246 000	340 000
280	380	63.5	63.5	48	3	2.5	32956XUUTG	930	1 520	95 000	155 000
	420	87	87	65	5	4	32056XUUTG	1 560	2 350	159 000	240 000
	500	89	80	67	5	5	30256UTG	1 590	1 910	162 000	195 000
	500	137	130	106	5	5	32256UTG	2 530	3 500	258 000	355 000
	580	187	175	145	6	6	32356UTG	4 200	5 250	425 000	535 000
300	420	76	76	57	4	3	32960XUUTG	1 290	2 090	131 000	213 000
	460	100	100	74	5	4	32060XUUTG	1 910	2 830	195 000	289 000
	540	96	85	71	5	5	30260UTG	1 820	2 220	186 000	226 000
	540	149	140	115	5	5	32260UTG	2 950	4 100	300 000	420 000
320	440	76	76	57	4	3	32964XUUTG	1 300	2 150	132 000	219 000
	480	100	100	74	5	4	32064XUUTG	1 940	2 940	198 000	300 000
	580	104	92	75	5	5	30264UTG	2 130	2 580	217 000	263 000
	580	159	150	125	5	5	32264UTG	3 350	4 650	340 000	470 000
340	460	76	76	57	4	3	32968XUUTG	1 340	2 270	136 000	232 000
	520	112	106	90	5	5	32068UTG	2 120	3 150	216 000	320 000
360	480	76	76	57	4	3	32972XUUTG	1 340	2 330	137 000	238 000
	540	112	106	90	5	5	32072UTG	2 230	3 300	227 000	340 000
380	520	87	82	72	4	4	32976UTG	1 460	2 500	148 000	255 000
	560	112	106	90	5	5	32076UTG	2 460	3 800	250 000	390 000
400	540	87	82	71	4	4	32980UTG	1 530	2 710	156 000	276 000
	600	125	118	100	5	5	32080UTG	2 790	4 250	284 000	435 000
420	560	87	82	71	4	4	32984UTG	1 570	2 840	160 000	290 000
	620	125	118	100	6	5	32084UTG	2 920	4 550	298 000	465 000
440	600	100	95	82	4	4	32988UTG	2 050	3 450	209 000	355 000
	650	130	122	104	6	6	32088UTG	3 250	5 000	330 000	510 000

1) Minimal allowable dimension for chamfer dimension  $r$  or  $r_1$ .

### 3. Dimension Table

#### 3.2 Double row tapered roller bearings (Outside direction)

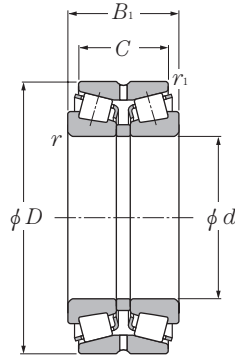

**Equivalent radial load**  
**dynamic**

$$P_r = XF_r + YF_a$$

$\frac{F_a}{F_r} \leq e$		$\frac{F_a}{F_r} > e$	
X	Y	X	Y
1	$Y_1$	0.67	$Y_2$

**static**

$$P_{0r} = F_r + Y_0 F_a$$

For values of  $e$ ,  $Y_2$ , and  $Y_0$  refer to that of conventional bearings.

d 130~200mm

d	Boundary dimensions mm					Bearing numbers	Basic load ratings			
	D	B <sub>1</sub>	C	r <sub>s</sub> min <sup>1)</sup>	r <sub>1s</sub> min <sup>1)</sup>		dynamic kN C <sub>r</sub>	static C <sub>0r</sub>	dynamic kgf C <sub>r</sub>	static C <sub>0r</sub>
130	280	137	107.5	5	1.5	430326XUUTG	1 420	1 660	145 000	169 000
	280	205	163.5	4	1.5	432326UTG	1 960	2 470	200 000	252 000
140	300	145	115.5	5	1.5	430328XUUTG	1 620	1 900	165 000	194 000
	300	223	177.5	4	1.5	432328UTG	2 170	2 740	221 000	279 000
150	320	154	120	5	1.5	430330UUTG	1 810	2 140	184 000	218 000
160	270	86	76	3	1	413132UTG	760	965	77 500	98 000
	270	108	86	3	1	423132UTG	865	1 180	88 500	120 000
	290	115	91	4	1	430232UUTG	1 150	1 440	118 000	147 000
	290	178	144	4	1	432232UUTG	1 950	2 840	199 000	290 000
	340	160	126	5	1.5	430332XUUTG	2 010	2 390	205 000	244 000
170	280	88	78	3	1	413134UTG	705	900	72 000	92 000
	280	110	88	3	1	423134UTG	930	1 270	94 500	130 000
	310	125	97	5	1.5	430234UUTG	1 340	1 690	136 000	173 000
	310	192	152	5	1.5	432234XUUTG	2 190	3 200	223 000	325 000
180	280	74	66	3	1	413036UTG	540	735	55 500	75 000
	280	93	74	3	1	423036UTG	745	1 050	76 000	107 000
	300	96	85	4	1.5	413136UTG	905	1 190	92 000	121 000
	300	120	96	4	1.5	423136UTG	1 130	1 530	116 000	156 000
	320	127	99	5	1.5	430236UUTG	1 380	1 780	141 000	182 000
	320	192	152	5	1.5	432236UUTG	2 260	3 350	230 000	345 000
190	290	75	67	3	1	413038UTG	550	740	56 500	75 500
	290	94	75	3	1	423038UTG	790	1 110	80 500	113 000
	320	104	92	4	1.5	413138UTG	1 000	1 280	102 000	131 000
	320	130	104	4	1.5	423138UTG	1 260	1 710	128 000	174 000
	340	133	105	5	1.5	430238UUTG	1 570	2 010	160 000	205 000
	340	204	160	5	1.5	432238UUTG	2 530	3 700	258 000	380 000
200	310	82	73	3	1	413040UTG	680	940	69 000	96 000
	310	103	82	3	1	423040UTG	920	1 320	94 000	135 000
	340	112	100	4	1.5	413140UTG	1 240	1 660	126 000	169 000
	340	140	112	4	1.5	423140UTG	1 400	1 910	143 000	195 000
	360	142	110	5	1.5	430240UUTG	1 730	2 210	176 000	226 000
	360	218	174	5	1.5	432240UUTG	2 890	4 250	295 000	435 000

1) Minimal allowable dimension for chamfer dimension  $r$  or  $r_1$ .



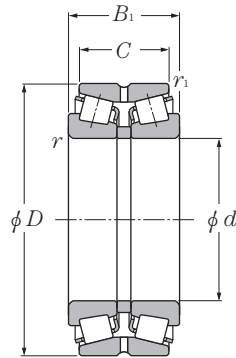

**Equivalent radial load dynamic**

$$P_r = XF_r + YF_a$$

$\frac{F_a}{F_r} \leq e$		$\frac{F_a}{F_r} > e$	
X	Y	X	Y
1	Y <sub>1</sub>	0.67	Y <sub>2</sub>

**static**

$$P_{0r} = F_r + Y_0 F_a$$

For values of  $e$ ,  $Y_2$ , and  $Y_0$  refer to that of conventional bearings.

**d 220~360mm**

d	Boundary dimensions mm					Bearing numbers	Basic load ratings			
	D	B <sub>1</sub>	C	r <sub>s</sub> min <sup>1)</sup>	r <sub>1s</sub> min <sup>1)</sup>		dynamic	static	dynamic	static
							C <sub>r</sub>	C <sub>0r</sub>	C <sub>r</sub>	C <sub>0r</sub>
220	340	90	80	4	1.5	413044UTG	765	1 060	78 000	108 000
	340	113	90	4	1.5	423044UTG	1 130	1 650	115 000	168 000
	370	120	107	5	1.5	413144UTG	1 420	1 920	145 000	196 000
	370	150	120	5	1.5	423144UTG	1 560	2 260	159 000	230 000
	400	158	122	4	1.5	430244UTG	1 790	2 440	183 000	249 000
240	360	92	82	4	1.5	413048UTG	835	1 160	85 500	118 000
	360	115	92	4	1.5	423048UTG	1 160	1 770	119 000	181 000
	400	128	114	5	1.5	413148UTG	1 580	2 130	161 000	217 000
	400	160	128	5	1.5	423148UTG	1 790	2 600	182 000	265 000
	440	165	127	4	1.5	430248UTG	2 140	2 960	219 000	300 000
	440	266	212	4	1.5	432248UTG	3 750	5 500	380 000	560 000
260	400	104	92	5	1.5	413052UTG	1 070	1 540	109 000	157 000
	400	130	104	5	1.5	423052UTG	1 470	2 190	150 000	223 000
	440	144	128	5	1.5	413152UTG	1 910	2 630	195 000	268 000
	440	180	144	5	1.5	423152UTG	2 510	3 750	256 000	380 000
280	420	106	94	5	1.5	413056UTG	1 140	1 630	116 000	166 000
	420	133	106	5	1.5	423056UTG	1 540	2 340	157 000	238 000
	460	146	130	6	2	413156UTG	2 100	2 900	214 000	296 000
	460	183	146	6	2	423156UTG	2 480	3 650	253 000	375 000
300	460	118	105	5	1.5	413060UTG	1 370	1 990	139 000	203 000
	460	148	118	5	1.5	423060UTG	2 070	3 150	211 000	320 000
	500	160	142	6	2	413160UTG	2 580	3 600	263 000	370 000
	500	200	160	6	2	423160UTG	2 690	4 050	274 000	415 000
320	480	121	108	5	1.5	413064UTG	1 520	2 250	155 000	229 000
	480	151	121	5	1.5	423064UTG	2 030	3 100	207 000	315 000
	540	176	157	6	2	413164UTG	2 870	4 100	292 000	415 000
	540	220	176	6	2	423164UTG	3 200	4 900	325 000	500 000
340	520	133	118	6	2	413068UTG	1 890	2 870	193 000	293 000
	520	165	133	6	2	423068UTG	2 420	3 750	246 000	380 000
	580	190	169	6	2	413168UTG	3 450	4 900	350 000	500 000
	580	238	190	6	2	423168UTG	4 300	6 500	440 000	660 000
360	540	134	120	6	2	413072UTG	1 880	2 810	191 000	287 000
	540	169	134	6	2	423072UTG	2 620	4 200	268 000	430 000
	600	192	171	6	2	413172UTG	3 500	5 050	355 000	515 000
	600	240	192	6	2	423172UTG	4 100	6 500	420 000	660 000

1) Minimal allowable dimension for chamfer dimension  $r$  or  $r_1$ .

### 3. Dimension Table

#### 3.2 Double row tapered roller bearings (Outside direction)

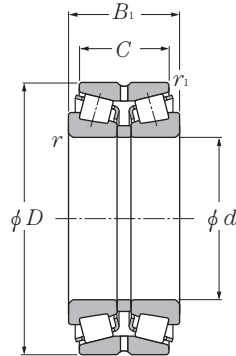

**Equivalent radial load dynamic**

$$P_r = XF_r + YF_a$$

$\frac{F_a}{F_r} \leq e$		$\frac{F_a}{F_r} > e$	
X	Y	X	Y
1	Y <sub>1</sub>	0.67	Y <sub>2</sub>

**static**

$$P_{0r} = F_r + Y_0 F_a$$

For values of  $e$ ,  $Y_2$ , and  $Y_0$  refer to that of conventional bearings.

d 380~710mm

d	Boundary dimensions mm					Bearing numbers	Basic load ratings			
	D	B <sub>1</sub>	C	r <sub>s</sub> min <sup>1)</sup>	r <sub>1s</sub> min <sup>1)</sup>		dynamic C <sub>r</sub> kN	static C <sub>0r</sub>	dynamic C <sub>r</sub> kgf	static C <sub>0r</sub>
380	560	135	122	6	2	413076UTG	2 160	3 350	221 000	340 000
	560	171	135	6	2	423076UTG	2 670	4 350	272 000	445 000
	620	194	173	6	2	413176UTG	3 650	5 250	370 000	535 000
	620	243	194	6	2	423176UTG	4 250	6 700	435 000	685 000
400	600	148	132	6	2	413080UTG	2 390	3 700	243 000	375 000
	600	185	148	6	2	423080UTG	3 250	5 450	330 000	555 000
	650	200	178	6	3	413180UTG	3 850	5 800	395 000	590 000
	650	250	200	6	3	423180UTG	4 800	7 850	490 000	800 000
420	620	150	134	6	2	413084UTG	2 700	4 250	276 000	435 000
	620	188	150	6	2	423084UTG	3 400	5 900	345 000	600 000
	700	224	200	6	3	413184UTG	4 700	7 200	480 000	735 000
	700	280	224	6	3	423184UTG	6 150	9 700	625 000	990 000
440	650	157	140	6	3	413088UTG	3 150	5 150	320 000	525 000
	650	196	157	6	3	423088UTG	3 350	5 450	340 000	560 000
	720	226	201	6	3	413188UTG	5 150	7 800	525 000	795 000
	720	283	226	6	3	423188UTG	6 400	10 300	650 000	1 050 000
460	680	163	145	6	3	413092UTG	3 350	5 350	340 000	550 000
	680	204	163	6	3	423092UTG	3 950	6 750	405 000	685 000
	760	240	214	7.5	4	413192UTG	5 850	9 150	595 000	930 000
	760	300	240	7.5	4	423192UTG	6 300	10 300	640 000	1 050 000
480	700	165	147	6	3	413096UTG	3 200	5 000	325 000	510 000
	700	206	165	6	3	423096UTG	3 900	6 700	400 000	685 000
	790	248	221	7.5	4	413196UTG	6 150	9 600	625 000	975 000
	790	310	248	7.5	4	423196UTG	6 750	11 100	690 000	1 130 000
500	720	167	149	6	3	4130/500UTG	3 350	5 400	340 000	550 000
	720	209	167	6	3	4230/500UTG	3 950	6 900	400 000	700 000
	830	264	235	7.5	4	4131/500UTG	6 700	10 500	680 000	1 070 000
	830	330	264	7.5	4	☆4231/500UTGG2	8 200	14 000	835 000	1 420 000
530	780	185	163	6	3	4130/530UTG	3 750	5 900	380 000	600 000
	870	340	272	7.5	4	☆4231/530AUTGG2	9 900	16 700	1 010 000	1 710 000
560	920	350	280	7.5	4	☆4231/560UTGG2	9 700	17 400	990 000	1 780 000
600	870	200	176	6	3	4130/600UTG	5 000	8 550	510 000	870 000
	980	388	300	7.5	4	☆4231/600UTGG2	10 950	18 400	1 120 000	1 870 000
670	1 090	392	336	7.5	4	☆4231/670UTGG2	13 450	24 800	1 370 000	2 530 000
710	1 030	236	208	7.5	4	☆4130/710UTGG2	7 550	13 900	770 000	1 420 000

1) Minimal allowable dimension for chamfer dimension  $r$  or  $r_1$ .

Remarks: Bearing numbers marked "☆" designate bearing with hollow rollers and pin type cages.

### 3.3 Double row tapered roller bearings (Inside direction)

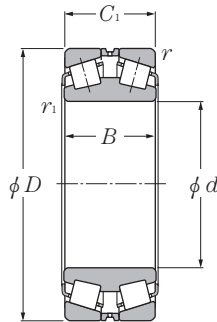

**Equivalent radial load**  
**dynamic**

$$P_r = XF_r + YF_a$$

$\frac{F_a}{F_r} \leq e$		$\frac{F_a}{F_r} > e$	
X	Y	X	Y
1	Y <sub>1</sub>	0.67	Y <sub>2</sub>

**static**

$$P_{0r} = F_r + Y_0 F_a$$

For values of  $e$ ,  $Y_2$ , and  $Y_0$  refer to that of conventional bearings.

d 160~710mm

Boundary dimensions mm						Bearing numbers	Basic load ratings			
d	D	B <sub>1</sub>	C	r <sub>s</sub> min <sup>1)</sup>	r <sub>1s</sub> min <sup>1)</sup>		dynamic C <sub>r</sub> kN	static C <sub>0r</sub>	dynamic C <sub>r</sub> kgf	static C <sub>0r</sub>
160	270	86	86	2.5	3	323132UTG	865	1 180	88 500	120 000
170	280	88	88	2.5	3	323134UTG	930	1 270	94 500	130 000
180	280	74	74	2.5	3	323036UTG	745	1 050	76 000	107 000
	300	96	96	3	4	323136UTG	1 130	1 530	116 000	156 000
190	290	75	75	2.5	3	323038UTG	790	1 110	80 500	113 000
	320	104	104	3	4	323138UTG	1 260	1 710	128 000	174 000
200	310	82	82	2.5	3	323040UTG	920	1 320	94 000	135 000
	340	112	112	3	4	323140UTG	1 400	1 910	143 000	195 000
220	340	90	90	3	4	323044UTG	1 130	1 650	115 000	168 000
	370	120	120	4	5	323144UTG	1 560	2 260	159 000	230 000
240	360	92	92	3	4	323048UTG	1 160	1 770	119 000	181 000
	400	128	128	4	5	323148UTG	1 790	2 600	182 000	265 000
260	400	104	104	4	5	323052UTG	1 470	2 190	150 000	223 000
	440	144	144	4	5	323152UTG	2 510	3 750	256 000	380 000
280	420	106	106	4	5	323056UTG	1 540	2 340	157 000	238 000
	460	146	146	5	6	323156UTG	2 480	3 650	253 000	375 000
300	460	118	118	4	5	323060UTG	2 070	3 150	211 000	320 000
	500	160	160	5	6	323160UTG	2 690	4 050	274 000	415 000
320	480	121	121	4	5	323064UTG	2 030	3 100	207 000	315 000
	540	176	176	5	6	323164UTG	3 200	4 900	325 000	500 000
340	520	133	133	5	6	323068UTG	2 420	3 750	246 000	380 000
	580	190	190	5	6	323168UTG	4 300	6 500	440 000	660 000
360	540	134	134	5	6	323072UTG	2 620	4 200	268 000	430 000
	600	192	192	5	6	323172UTG	4 100	6 500	420 000	660 000
400	600	148	148	5	6	323080UTG	3 250	5 450	330 000	555 000
	650	200	200	6	6	323180UTG	4 800	7 850	490 000	800 000
420	620	150	150	5	6	323084UTG	3 400	5 900	345 000	600 000
	700	224	224	6	6	323184UTG	6 150	9 700	625 000	990 000
440	650	157	157	6	6	323088UTG	3 350	5 450	266 000	560 000
	720	226	226	6	6	323188UTG	6 400	10 300	510 000	1 050 000
460	680	163	163	6	6	323092UTG	3 950	6 600	310 000	670 000
	760	240	240	7.5	7.5	323192UTG	6 300	10 300	500 000	1 050 000
480	700	165	165	6	6	323096UTG	3 900	6 700	400 000	685 000
	790	248	248	7.5	7.5	323196UTG	6 750	11 100	540 000	1 130 000
500	720	167	167	6	6	3230/500UTG	3 950	6 900	400 000	700 000
	830	264	264	7.5	7.5	☆3231/500UTGG2	8 200	14 000	650 000	1 420 000
630	920	212	212	7.5	7.5	☆3230/630UTGG2	6 850	12 800	545 000	1 310 000
710	1 150	345	345	12	12	☆3231/710BUTGG2	14 000	25 300	1 430 000	2 580 000

1) Minimal allowable dimension for chamfer dimension  $r$  or  $r_1$ .

Remarks: Bearing numbers marked "☆" designate bearing with hollow rollers and pin type cages.